

GHM-250V Swinging Hanger

Parts Included

- Raised countersunk head wood screw 3.5×20 (SUS)

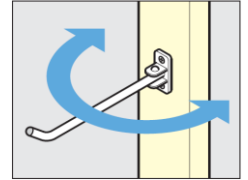
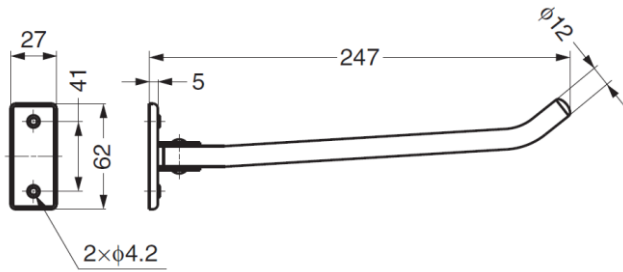

Part No.	Material	Finish	Load Capacity	
GHM-250V	Stainless Steel 304 / EPDM	Satin	29.4 N	3 kg

GHM-250Y Swinging Hanger

Parts Included

- Raised countersunk head wood screw 3.5×20 (SUS)

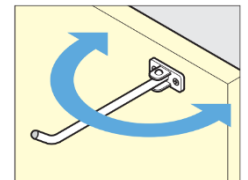
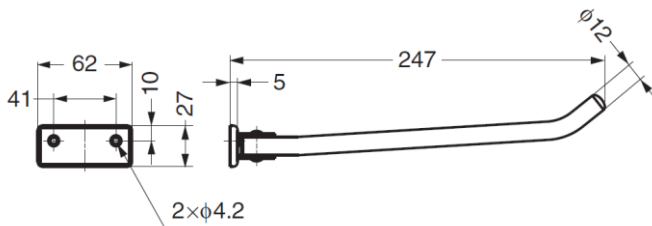

Part No.	Material	Finish	Load Capacity	
GHM-250Y	Stainless Steel 304 / EPDM	Satin	29.4 N	3 kg

GHM-330 Swinging Hanger

Parts Included

- Raised countersunk head wood screw 3.5×20 (SUS)

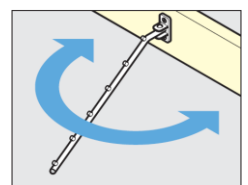
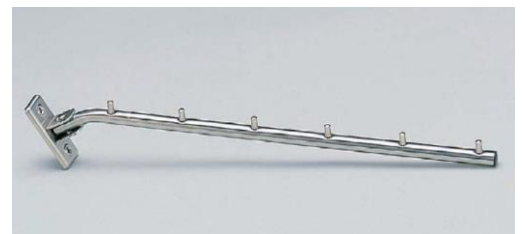
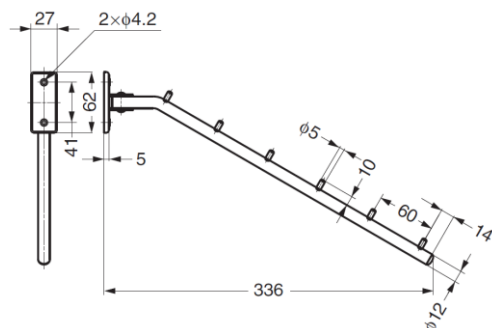

Part No.	Material	Finish	Load Capacity	
GHM-330	Stainless Steel 304 / EPDM	Satin	29.4 N	3 kg